



Part of GE's Sensing & Inspection Technologies business

RHM 04

Universal Coriolis Mass Flowmeter with particular Fast Response

The RHM 04 can measure flow rates up to 10 kg/min (22 lb/min) with extremely fast response times and excellent repeatability. A true solution, particularly for application such as batching where fast response times are needed, manufactured by Rheonik, the mass flowmeter experts.

Applications

Suitable for virtually any mass flow application, such as:

- General flow control
- Batching
- Injections
- Dosing
- Filling

Features

The outstanding features include:

- Suitable for pressure up to 250 bar
- Typical measuring ranges from 0.1 kg/min to 10 kg/min (21 lb/min)
- Minimal flows as low as 0.05 kg/min
- Response times of 30 ms and better
- Flow Accuracy of 0.10%
- Repeatability better than 0.05%

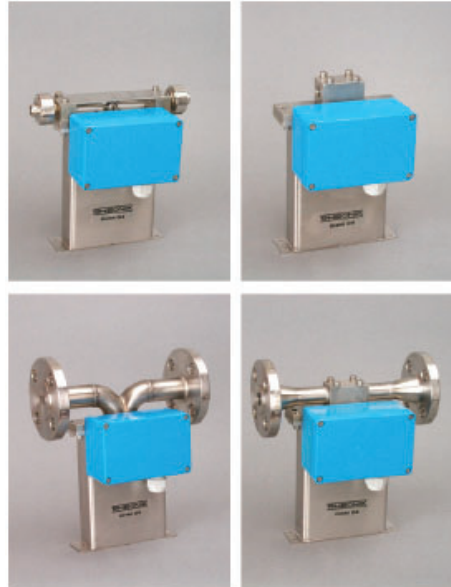

- Optimised solutions for your batching operation
- Extra compact design with minimal space requirement
- EEx Approvals (i.e. ATEX, CSA, ...)
- Custody Transfer Approvals (i.e. PTB, NMI, ...)

Advantages

- No pressure effect – no deterioration of accuracy due to pressure changes by the patented Omega Shape
- Patented torsion swinger design assures longest life time and increased safety (low stress in welds and increased wall thickness against abrasion)
- No moving parts – practically no maintenance
- Removable connection block



General

The RHM 04 is an economical meter which has been in production for over 15 years. This meter has been optimized for applications which require extreme stability and fast response.

As with all other Rheonik meters, this model is based on the patented Omega tube design with increased signal to noise ratio.

This unique design, which offers excellent performance and reliability, has created the most satisfied customers worldwide. Unlike other mass flowmeters, Rheonik uses a patented torsion swinger with the Omega shape and support bars which results in high accuracy measurement, which is independent of pressure, even at very low flow velocities. The meter has also extremely good repeatability and high stability for critical applications.

RHM 04 Specifications

Performance RHM 04

Max Flow 10 kg/min (22 lb/min)

Standard Models			
Rates/turndown ratio	in (kg/min)	in (lb/min)	error in % of reading
nominal rate Q_{nom}	10.000	22.05	0.15
$0.2 * Q_{max}$ (5:1)	2.000	4.41	0.20
$0.1 * Q_{max}$ (10:1)	1.000	2.21	0.20
$0.05 * Q_{max}$ (20:1)	0.500	1.10	0.20
$0.02 * Q_{max}$ (50:1)	0.200	0.44	0.50

Typical ΔP in bar (psi)	
1 cP	100 cP
0.7 (11)	5.8 (84.8)
~ 0 (0.6)	1.2 (16.7)
~ 0 (0.2)	0.6 (8.3)
~ 0 (0)	0.3 (4.3)
~ 0 (0)	0.1 (1.7)

Optimized Low Flow Models ^(*) /optimized to be operated between $0.01 * Q_{max}$ and $0.3 * Q_{max}$			
Rates/turndown ratio	in (kg/min)	in (lb/min)	error in % of reading
$0.3 * Q_{max}$ (1:1)	3.000	6.61	0.15
$0.02 * Q_{max}$ (15:1)	0.200	0.44	0.20
$0.015 * Q_{max}$ (30:1)	0.100	0.22	~ 0.50 ^(**)

0.1 (1.2)	1.8 (25.1)
~ 0 (0)	0.1 (1.7)
~ 0 (0)	~ 0 (0.9)

^(*) serial/single path version offers the same accuracy at half the flow ($Q_{max} = 5 \text{ kg/min}$)

^(**) around 0.30 - 0.70 % accuracy depending on the installation conditions

Gold Line Models/application fine tuned meters			
Rates/turndown ratio	in (kg/min)	in (lb/min)	error in % of reading
$1 * Q_{nom}$ (1:1)	10.000	22.05	0.10
$0.1 * Q_{nom}$ (10:1)	1.000	2.21	0.10
$0.05 * Q_{nom}$ (20:1)	0.500	1.10	0.12

0.7 (11)	5.8 (84.8)
~ 0 (0.2)	0.6 (8.3)
~ 0 (0)	0.3 (4.3)

Repeatability

better ± 0.05 % of rate

Temperature

Better $\pm 1^\circ\text{C}$

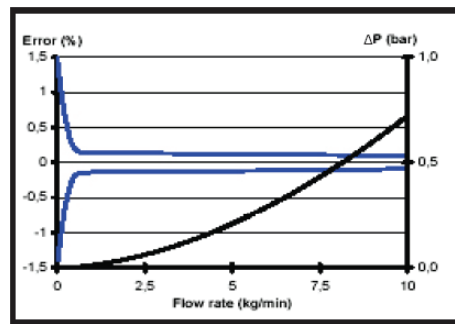
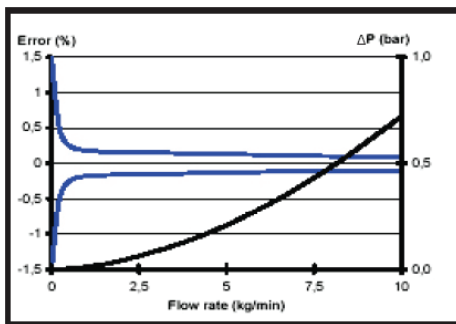

Standard Models

Gold Line Models

For serial (single pipe/path) sanitary design Q_{max} is 5 kg/min (50%). Data above refer to standard wall thickness.

Error of reading (including zero drift) indications refer to reference conditions H_2O , 18-24°C (66-76°F), 1-3 bar (15-45 psi).

RHM sensor do not suffer from pressure effect due to torsional oscillation and semi circle (non-deforming) measurement section.

Temperature changes of $\pm 25^\circ\text{C}$ around the operating point are negligible.

Pressure drop refers to Newton liquids, with parallel measuring loops and block/manifold connection.

Nominal flow refers to approx. 10 m/s (33 ft/sec) velocity in measuring loops for best performance.

Calibration to customer range, with increased accuracy, possible.

General Outline Dimensions RHM 04

Type I (w/removable manifold block - serial [SM0]/parallel [PM0]/PTFE seals)

Thread Type:

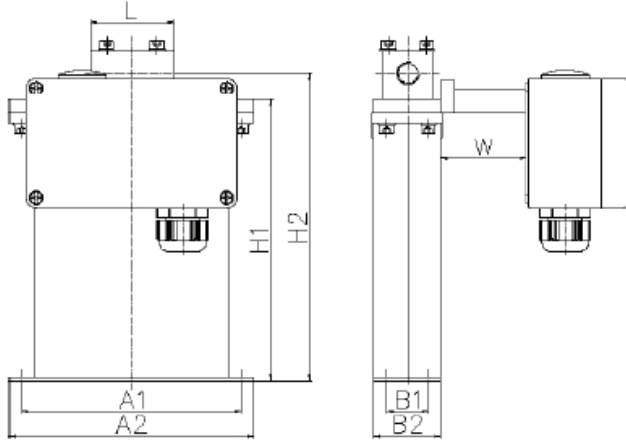

Weight approx. 2.5 kg (5.5 lb)

Flange Type:

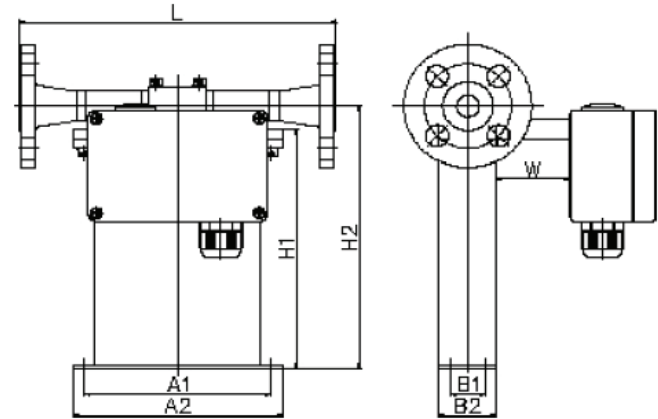

Weight approx. 3.5 kg (7.7 lb)

A1=130 mm (5.12 in) B1=25 mm (0.98 in) H1=172 mm (6.77 in)
 A2=145 mm (5.71 in) B2=40 mm (1.57 in) H2=188 mm (7.40 in)
 H2=196.5 mm (7.74 in) for brazed block version

W = 0 mm for standard temperature models -45/-20°C to 120°C (-49/-4°F to 248°F) and W = 100 mm (3.96 in) for extended (ET1, ET2) and high temperature models(*)

Process Connection		Face to Face Length (L) (**)	Order Code
Thread Standard	G ¼ in female	50 mm (1.97 in)	G1
	NPT ¼ in female	50 mm (1.97 in)	N1
Thread Optional	Autoclave/Butech thread	70 mm (2.76 in)	P1
	M20 x 1.5	70 mm (2.76 in)	XX
Flange Standard	½ in CL 150 acc. ANSI B16.5	220 mm (8.67 in)	A1
	½ in CL 300 acc. ANSI B16.5	220 mm (8.67 in)	A2
	½ in CL 600 acc. ANSI B16.5	220 mm (8.67 in)	A3
	DN15/PN40 acc. DIN 2635 - C	220 mm (8.67 in)	D1
	DN15/PN100 acc. DIN 2637 - E	220 mm (8.67 in)	D2
Flange Optional	½ in CL 900/1500 acc. ANSI B16.5	300 mm (11.82 in)	A6
	DN15/PN160 acc. DIN 2638 - E	220 mm (8.67 in)	D3
Special	½ in JIS flanges	standard - 220 mm (8.67 in)	XX
	Swagelok	standard - 190 mm (7.48 in)	XX
	VCR	standard - 190 mm (7.48 in)	XX
	Novaswiss	standard - 190 mm (7.48 in)	XX

(*) Type II or Type III preferred - see next pages.

(**) Customization possible on request.

Our standard seals are PTFE - Manifold block on request available without seals but with brazed connection block.

The finish type of our ANSI flanges is RF/SF (AARH 125-250 (µ in) - Ra 3,2 up to 6,3 (µm)). Others available on request.

Above table only shows our general process fittings.

For further customization with regard to face to face length and special fittings please contact your local agent.

General Outline Dimensions RHM 04

Type II (sealless welded, parallel measuring loops w/o seals [PF_])

Flange Type:

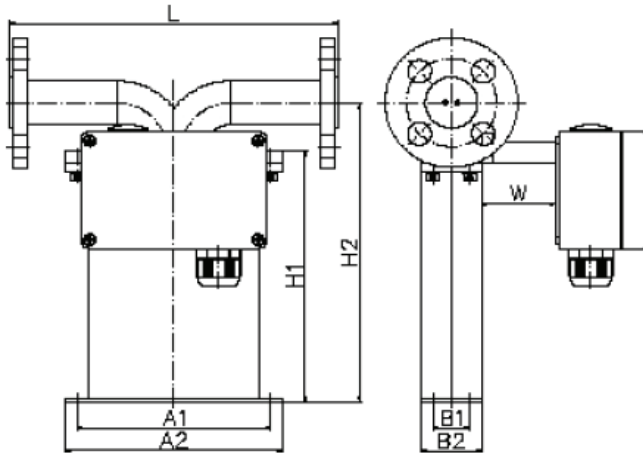

Weight approx. 3.5 kg (7.7 lb)

A1=130 mm (5.12 in) B1=25 mm (0.98 in) H1=172 mm (6.77 in)
 A2=145 mm (5.71 in) B2=40 mm (1.57 in) H2=205 mm (8.07 in)

W = 0 mm for standard temperature models -45/-20°C to 120°C (-49/-4°F to 248°F)
 and W = 100 mm (3.96 in) for extended (ET1, ET2) and high temperature models

Special Fittings:

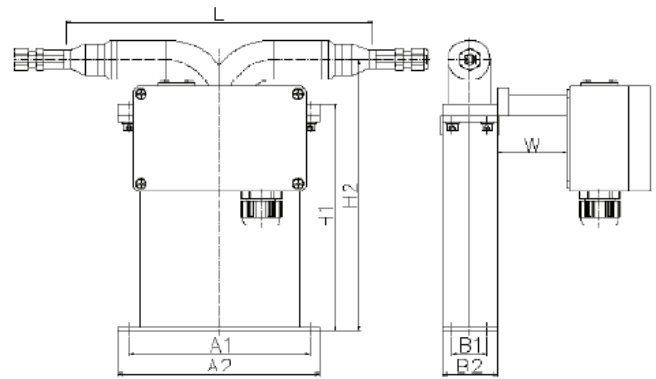

Weight approx. 3.5 kg (7.7 lb)

Process Connection	Face to Face Length (L) (**)	Order Code
Standard	½ in CL 150 acc. ANSI B16.5	A1
	½ in CL 300 acc. ANSI B16.5	A2
	½ in CL 600 acc. ANSI B16.5	A3
	DN15/PN40 acc. DIN 2527 - C	D1
	DN15/PN100 acc. DIN 2527 - E	D2
Optional	½ in CL 900/1500 acc. ANSI B16.5	A6
	DN15/PN160 acc. DIN 2527 - E	D3
Special	G ¼ in female	G1
	NPT ¼ in female	N1
	Swagelok ¼ in tube inlet (SS-400-1-4W)	W1
	½ in JIS flanges	XX
	Free pipe ends 12.00 x 1.50 mm	XX
Grayloc or equivalent hubb	XX	

(*) Customization possible on request.

The finish type of our ANSI flanges is RF/SF (AARH 125-250 (µinch) - Ra 3,2 up to 6,3 (µm)). Others available on request.

Above table only shows our general process fittings.

For further customization with regard to special fittings and face to face length please contact your local agent.

General Specifications RHM 04

Approvals

- ATEX (CESI 02 ATEX 053 X): Ex II 1 G, EEx ia IIC T6-T1
- CSA (220705) Class I, Div 1 and 2, Groups A, B, C and D; Type 3
- Custody Transfer Approvals (PTB 1.32-97027224 and NMI TC 3382)
- PED according to directive 97/23/EC available
- 3A Sanitary Approvals

Electrical Connection

- Junction box/aluminium coated (standard) IP 65 (Nema 4X) (Junction box in SS optional)
- Cable entry M25 x 1.5 (M20 x 1.5, ½ in and ¾ in NPT optional)
- Max cable length between RHM and RHE: 100 m (330 ft) 200 m (660 ft) only with factory approval

Housing

- Stainless Steel: 1.4301/SS 304
 - others on request -
- Protection class: IP 65 (Nema 4X)
 - higher on request -

Material of Wetted Parts

- 1.4539/SS 904L (measuring loops)
- 1.4571/SS 316Ti (process connection)
- Hastelloy C22 on request
- Other material on request

Pressure Rating

- Pressured part of the meter consists of the measuring loops and the connection part. The weaker of both parts decides the maximum allowed operating pressure. Below is the max. operating pressure of the measuring loops(*).

() These values are only valid for SS 316Ti & SS 904L materials. Statements for others materials on request.*

- **Standard Version:**

150 bar @ 120°C (2175 psi @ 248°F)
120 bar @ 210°C (1740 psi @ 410°F)
100 bar @ 350°C (1450 psi @ 662°F) wall thickness is generally 0.3 mm (0.012 in)

- **Optional high pressure version:**

250 bar @ 120°C (3625 psi @ 248°F) wall thickness is generally 0.5 mm (0.019 in)

- **Extremely high pressure**

- on request -

Temperature Rating

- NT Models from -20°C to 120°C (-4°F to 248°F)
- ET Models from -45°C to 120°C (-49°F to 248°F)
- ET1 Models from -200°C to 50°C (-328°F to 122°F)
- ET2 Models from -45°C to 210°C (-49°F to 410°F)
- HT Models from 0°C to 350°C (32°F to 662°F)

Order Code RHM 04

Order Code Structure

The order code of the Rheonik Sensors consists of 6 sections (see previous pages/below). Restrictions of combinations may apply. For specials, please comment your needs in plain text/sketches.

RHM 04

Temperature Rating

- T1** NT Models (Normal Temperature Models) from -20°C to 120°C (-4°F to 248°F)
- TA** ET Models (Extended Temperature Models) from -45°C to 120°C (-49°F to 248°F)
- T2** ET2 Models (Extended Temperature Models) from -45°C to 210°C (-49°F to 410°F)
- T3** ET1 Models (Extended Temperature Models) from -200°C to 50°C (-328°F to 122°F)
- T4** HT Models (High Temperature Models) from 0°C to 350°C (32°F to 662°F)

Pressure Rating

- P1** Standard pressure version (150 bar @ 120°C/2175 psi @ 248°F) - page 6 -
- P2** High pressure version (250 bar 120°C/3625 psi @ 248°F) - page 6 -
- PX** Extremely high pressure version (on request) - page 6 -

Construction Type

- PM0** Parallel Measuring Loops with removable Block/Manifold and PTFE Seals - page 3 -
- SMO** Serial Measuring Loops with removable Block/Manifold and PTFE Seals - page 3 -
- PF_** Parallel Measuring Loops Seal Less Welded Version - page 4 -
- SFO** Serial Measuring Loops Seal Less Welded Version/Single Path - page 5 -

Material of Wetted Parts

- M0** 1.4539/SS 904L (measuring loops) 1.4571/SS 316Ti (connection part)
- M5** Hastelloy C4 (measuring loops)/Hastelloy C22 (connection part)
- MX** Other material on request

Process Connection

- XX** Code available on pages 3, 4 and 5.

Hazardous Area Approvals

- NN** Without Ex Approvals
- AT** ATEX Approvals (CESI 02 ATEX 053 X) - Ex II 1 G, EEx ia IIC T6-T1
- CS** CSA Approvals (220705) - Class 1, Div 1/Group A, B, C, and D; Type 3

RHM 04 - - - - - -

Order Code Example

M#04 T1 P1 PM0 M0 G1 AT

- T1:** NT (Normal Temperature Models) from -20°C to 120°C (-49°F to 248°F)
- P1:** Standard pressure version (150 bar @ 120°C/2175 psi @ 248°F)
- PM0:** Parallel Measuring Loops with removable Block/Manifold and PTFE Seals
- M0:** 1.4539/SS 904L (measuring loops) 1.4571/SS 316Ti (connection part)
- G1:** Female Thread G ¼ in
- AT:** ATEX Approvals (CESI 02 ATEX 053 X)

M #04 - - - - - -



www.gesensinginspection.com

920-000-01